

THE PROPERTY OF THE DRAWING IS ESTABLISHED BY LAW. IT IS FORBIDDEN TO PRODUCE OR SHOW IT TO THIRD PART. WITHOUT A WRITTEN AGREEMENT.

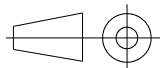
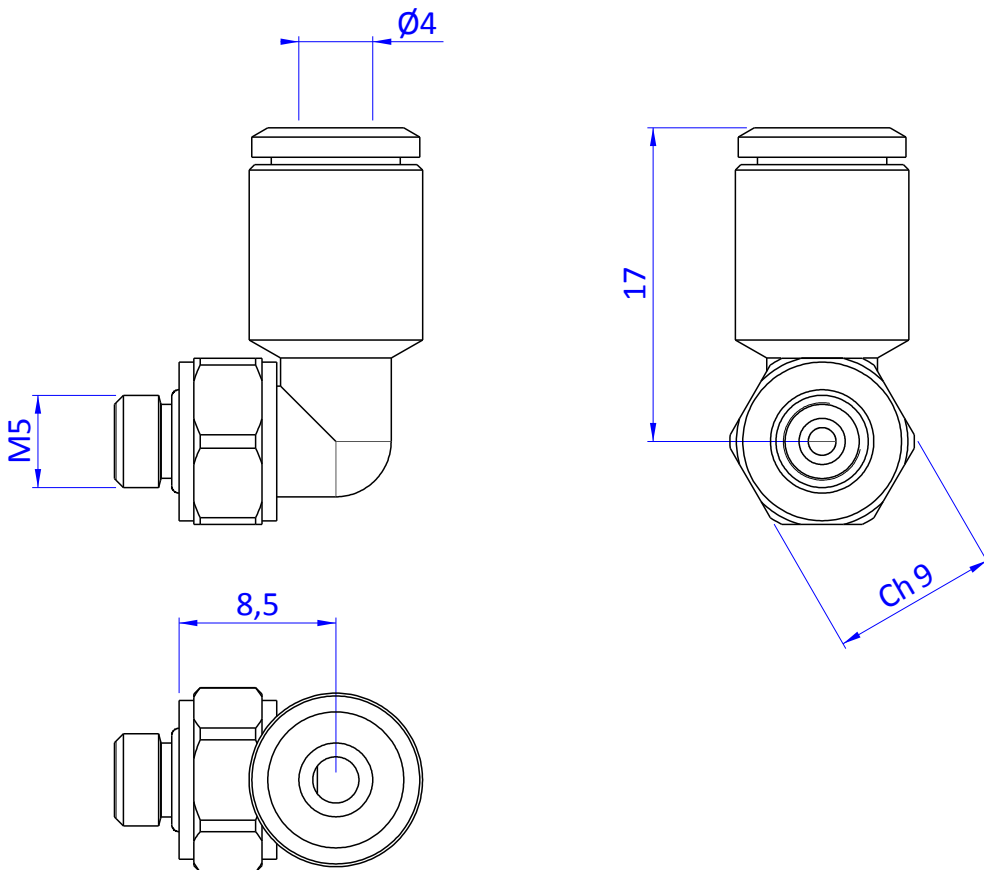
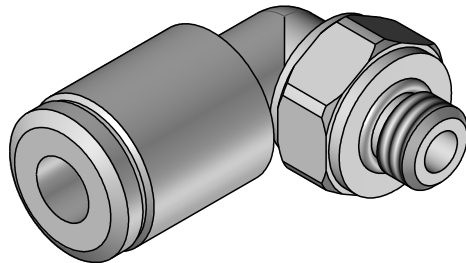

DESIGNED FROM		REVIEW
FPS Automation		A
DATE	WEIGHT	
23/08/2016	0,004kg	
CODE		
CA.12.05.001		

Format A4
UNI 936-76

GENERAL TOLERANCE
UNI - ISO 2768
CLASSE f

DESCRIPTION
CA.12.05.001